

1 Uitgangssituaties

1.1 Wijkcentrum

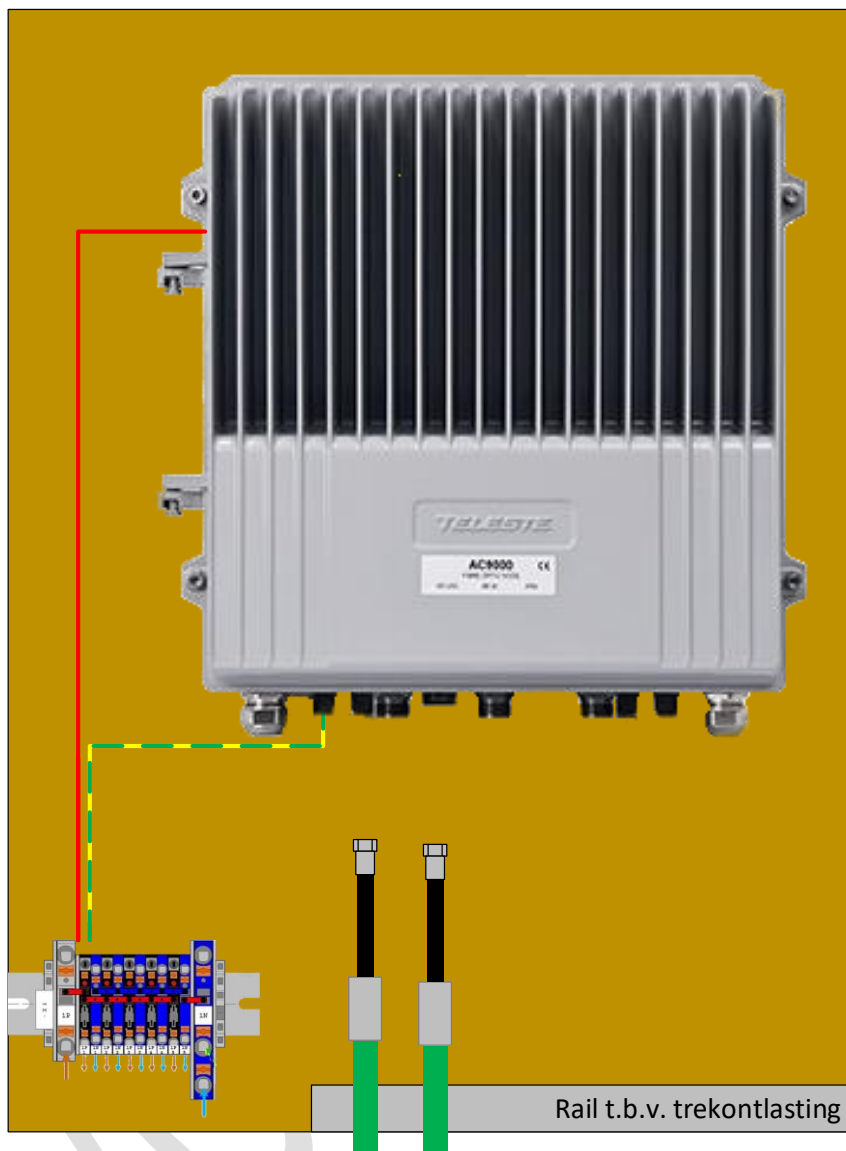

1.2 Groepversterker

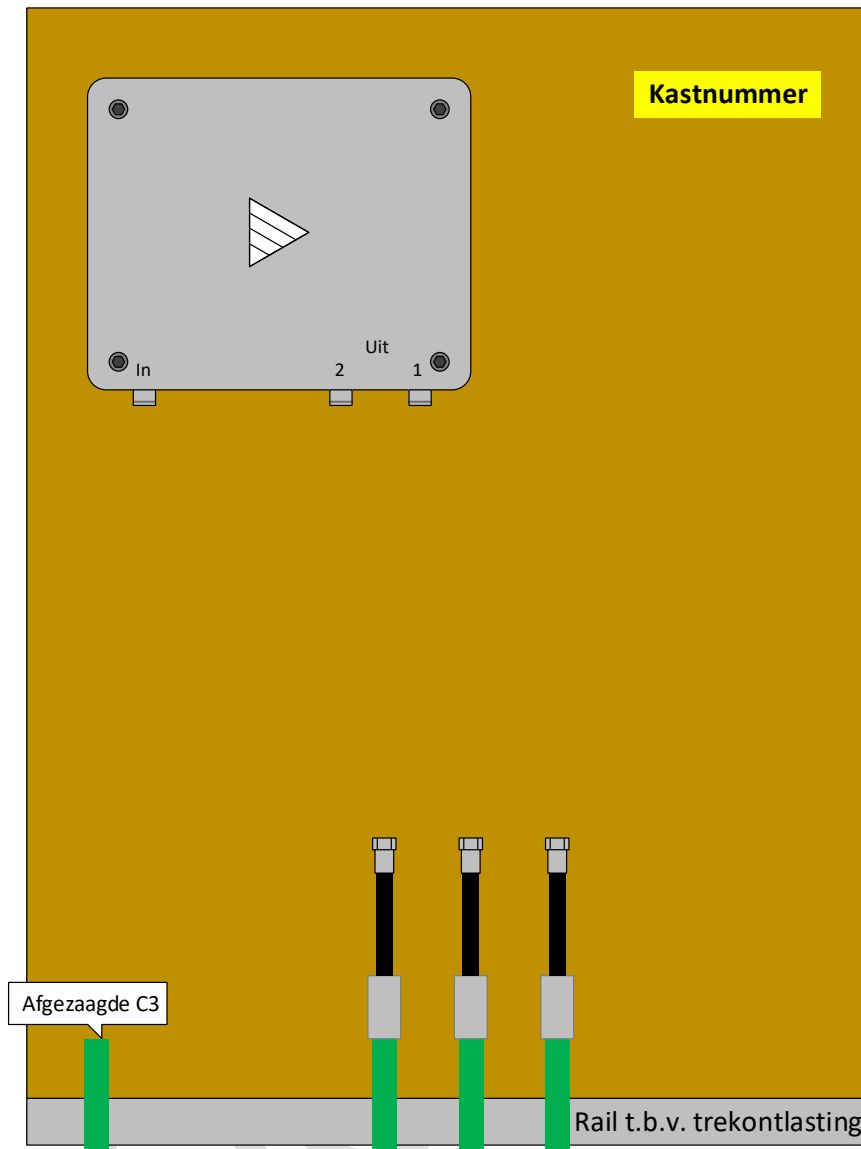

1.3 Eindversterker met minister

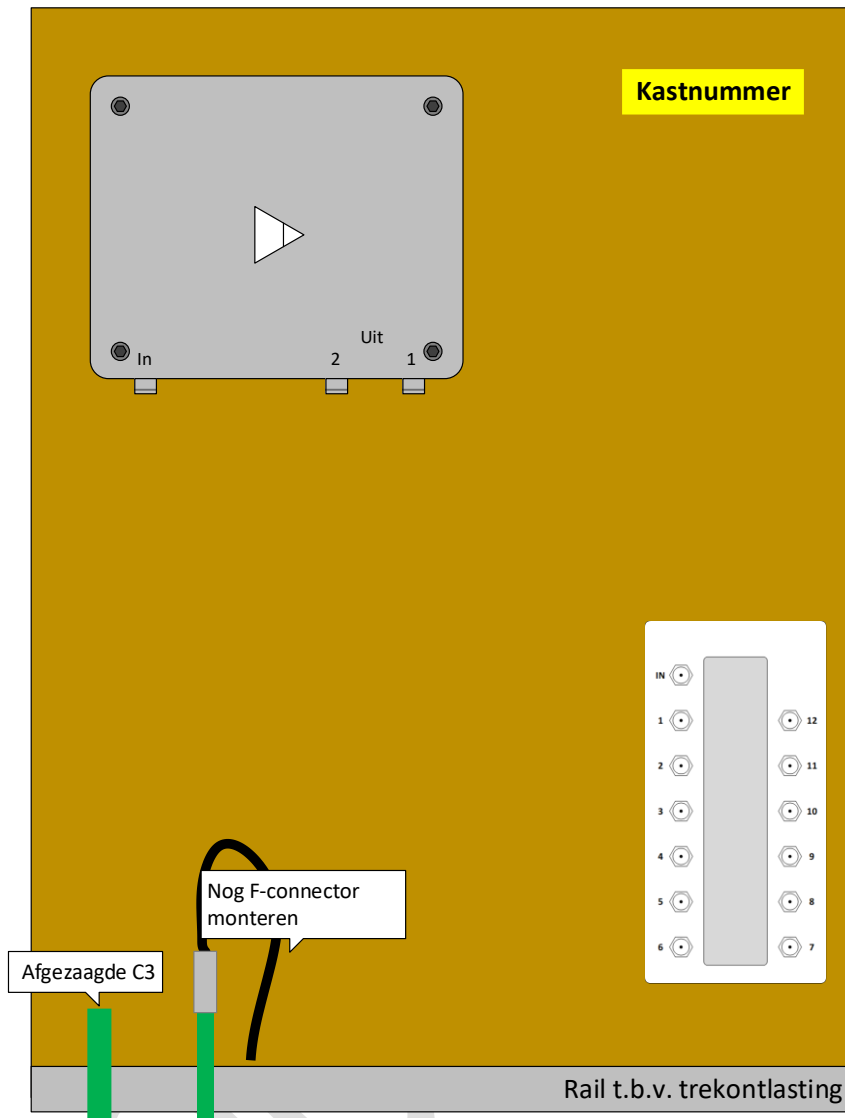

2 Bijlagen op locatie

2.1 Montagevoorschrift Wijkcentrum 1x node

Voorbeeld:

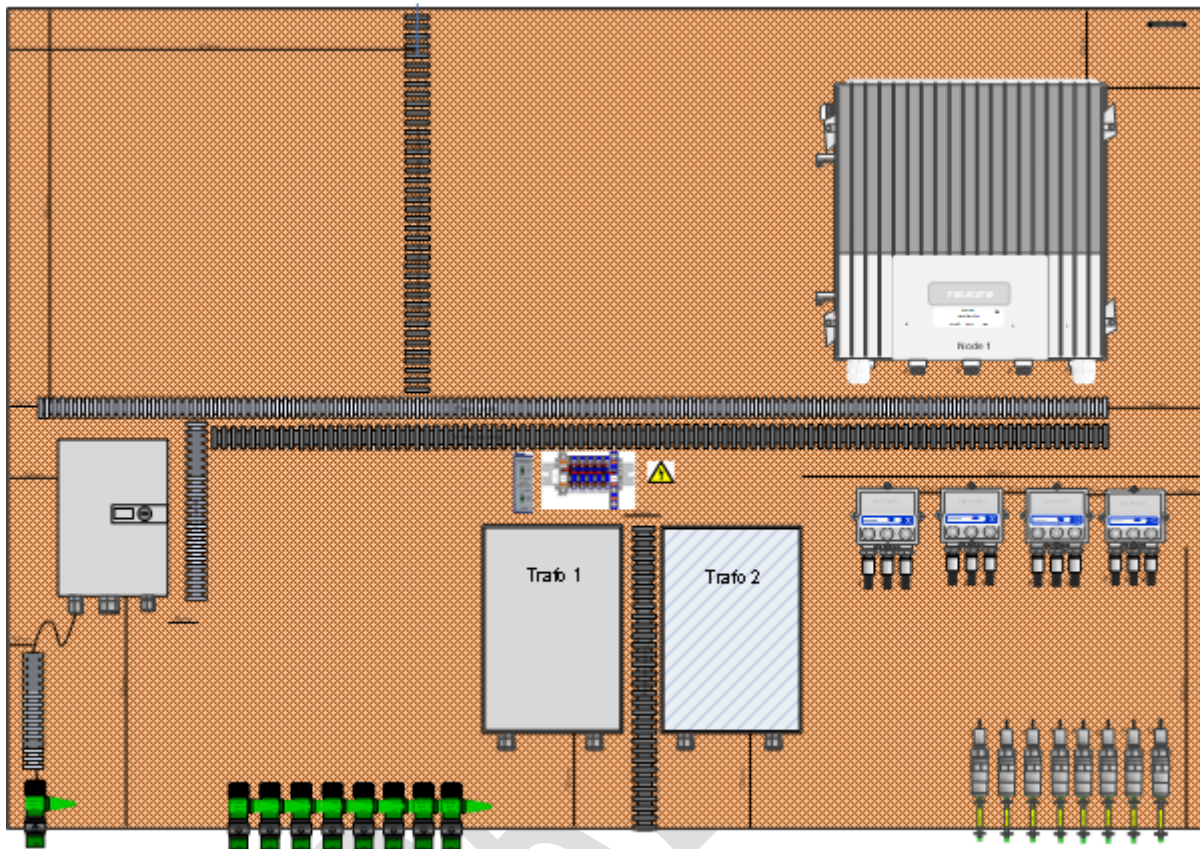

2.2 Montagevoorschrift groepversterker

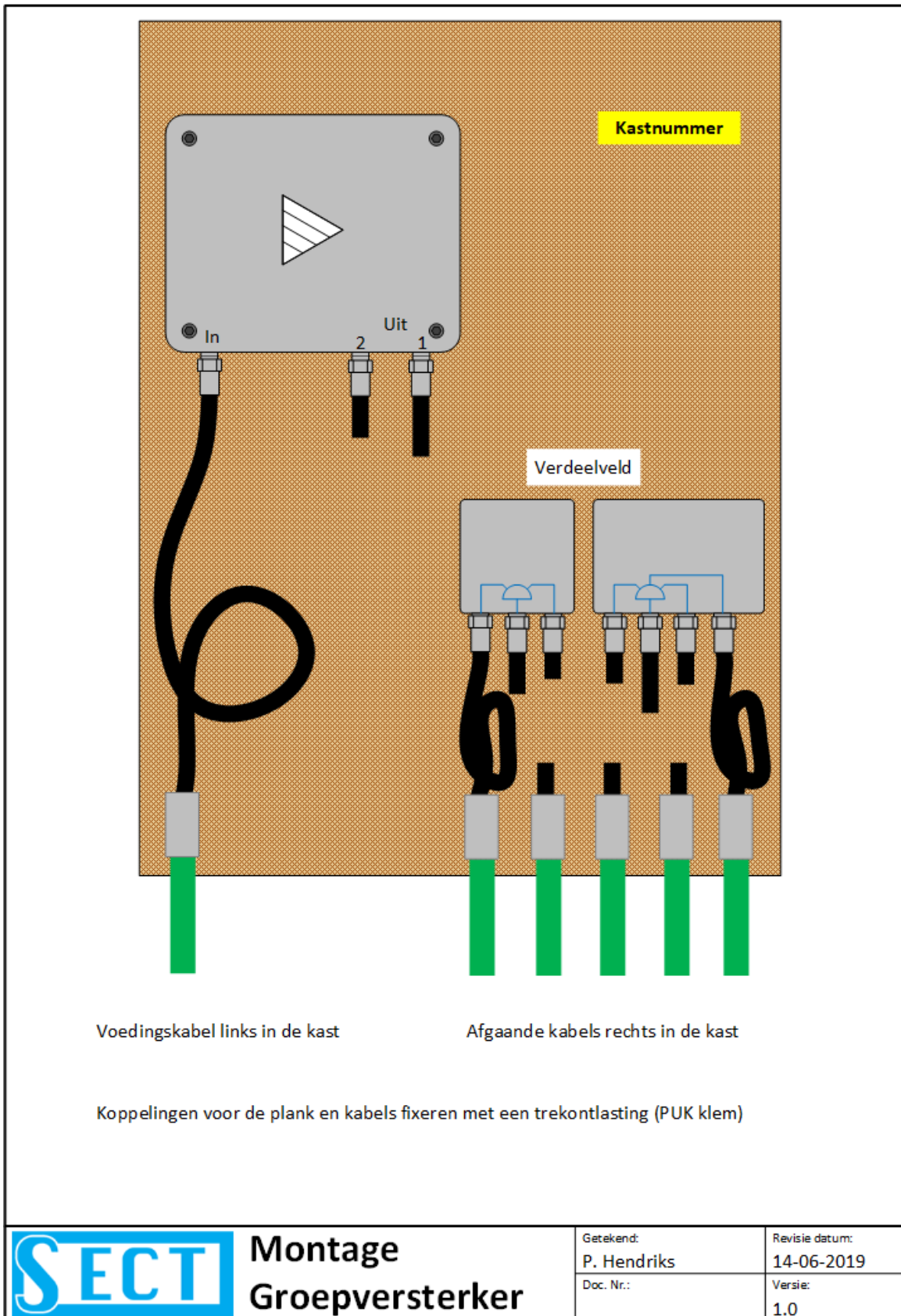

2.3 Montagevoorschrift eindversterker

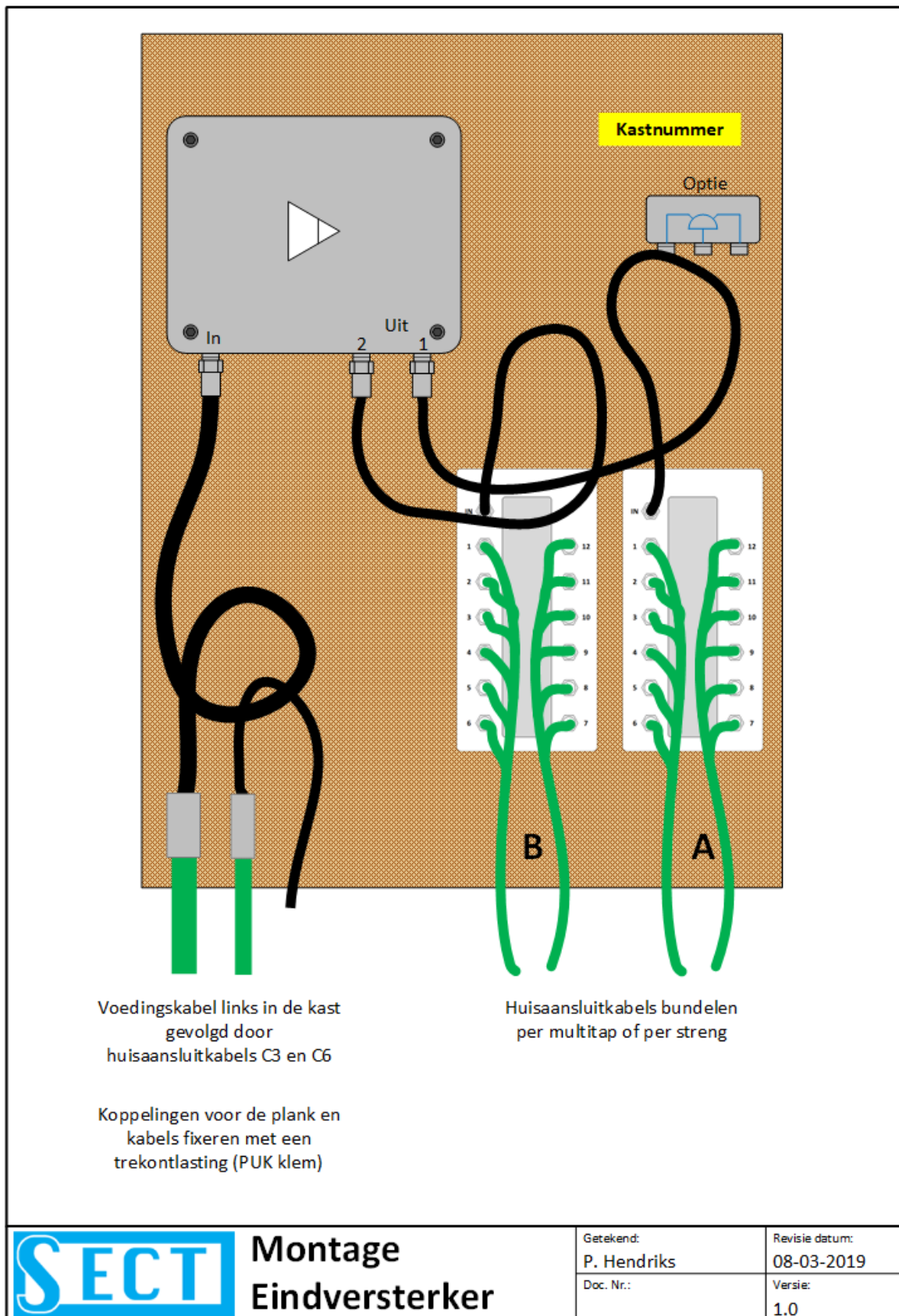

2.4 Ministerlijst

Sterpunt-nr.:	09-01-07	Type:	DBC1200 type 2	
WC-locatie:	Hoofdstraat 1	Kasttype:	Z480	
GV-locatie:	Telestestraat 2	Retour:	UNI EV	
EV-locatie:	Bremistraat 9	Aantal taps:	24	
Opmerking:	Niveaus: QAM256	Woonplaats:	Trailerdorp	

DBC1200 type 2				
Uitgang 1 : DMV12 C9				
Uitgang 2 : -----				
	85	440	470	860
In:	23	20	18	15
Uit:	35	35	35	35
Uit:	35	35	35	35

MT	TP	Straat	Nr	Toev	R	Postcode	Kab	Len	Res	Wcd	80	232	440	536	816	Status
DMV12 C9																
A	1	-----					C9				153					
A	2	-----					C9				147					
A	3	-----					C9				139					
A	4	-----					C9				132					
A	5	Bremistraat	16			4061 ZZ	C6	110		85 AOP	9,5	8,8	8,9	9,1	10,1	
A	6	-----					C9				115					
A	7	-----					C9				111					
A	8	-----					C9				105					
A	9	-----					C9				99					
A	10	-----					C9				93					
A	11	-----					C9				88					
A	12	-----					C9				84					

Totaal lengtes:	C9	0
	C6	110
Aantal aansluitingen:		1
Generatie datum:	28-7-2020	

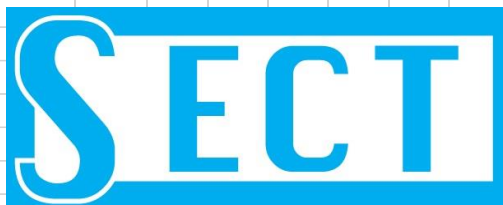

2.5 Blokschema WC

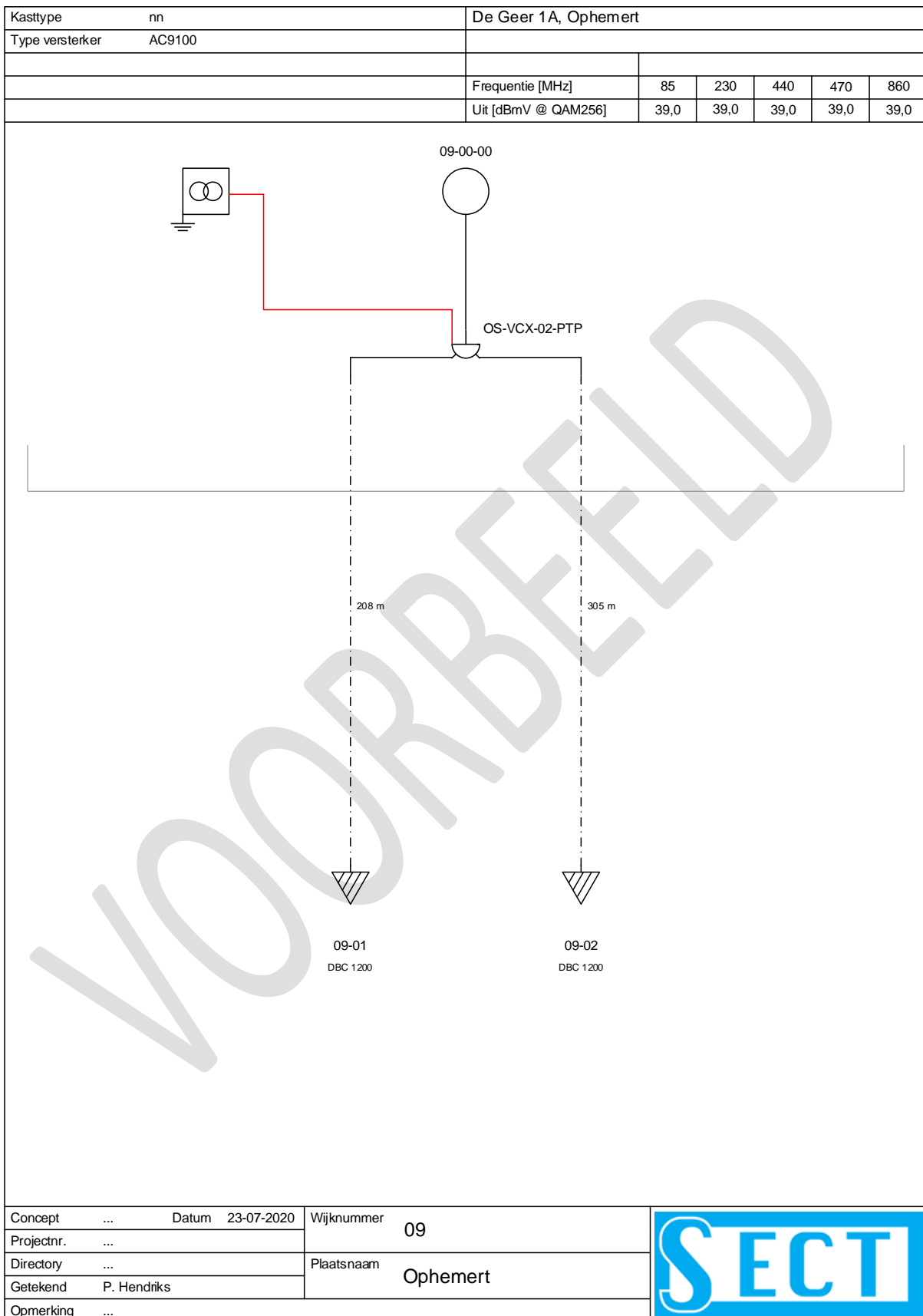

2.6 Blokschema GV

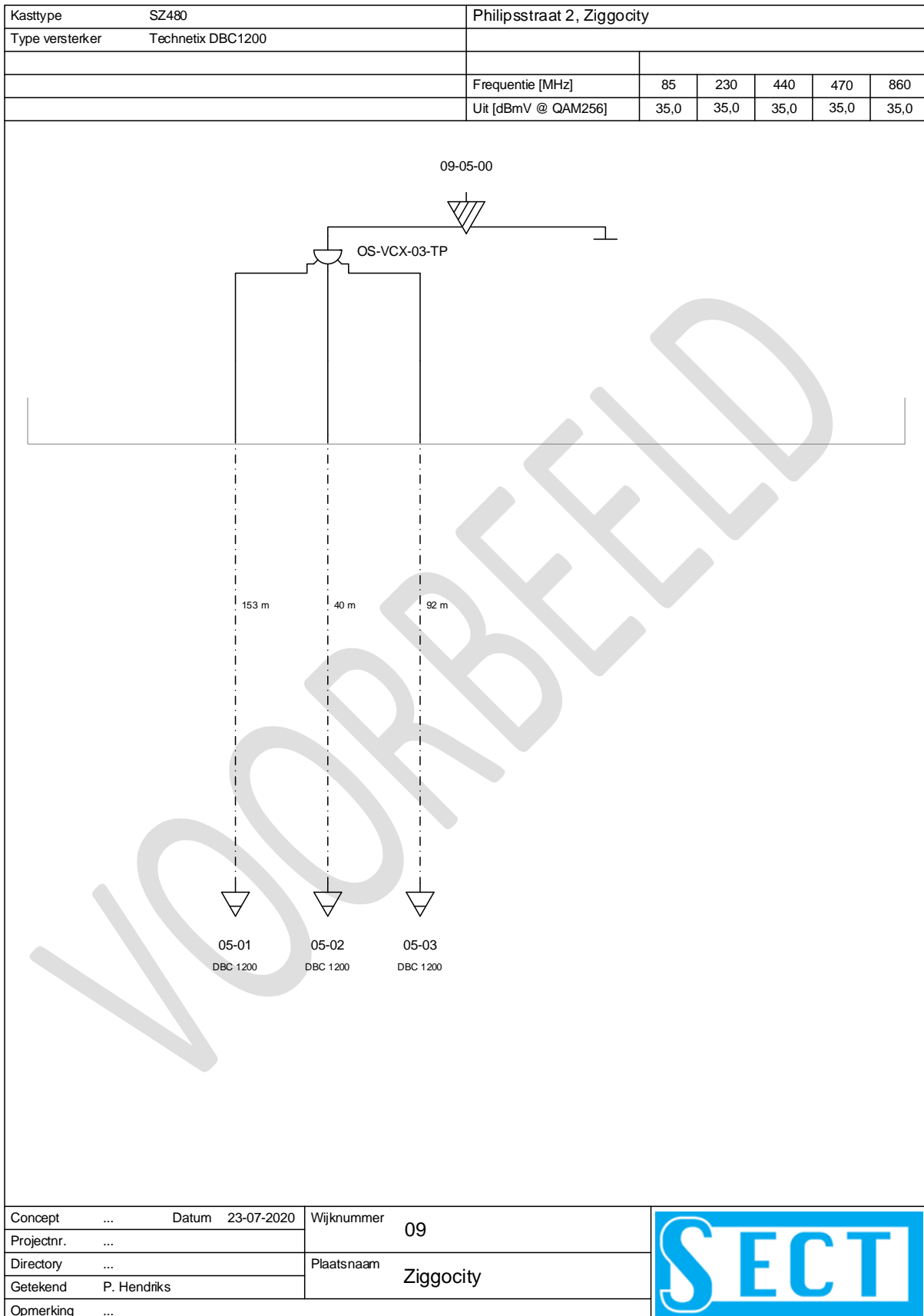

2.7 SECT zekeringplan

