

# 1 Uitgangssituaties

## 1.1 Wijkcentrum

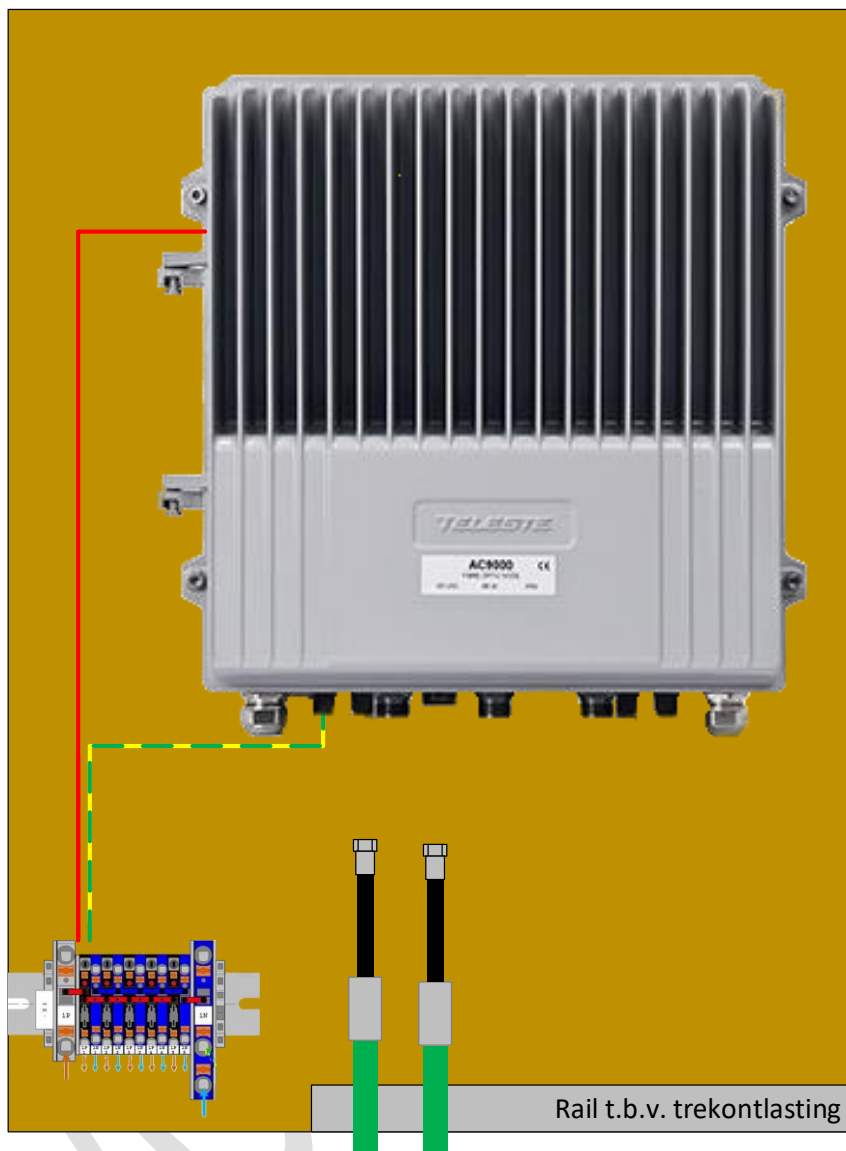

## 1.2 Groepversterker

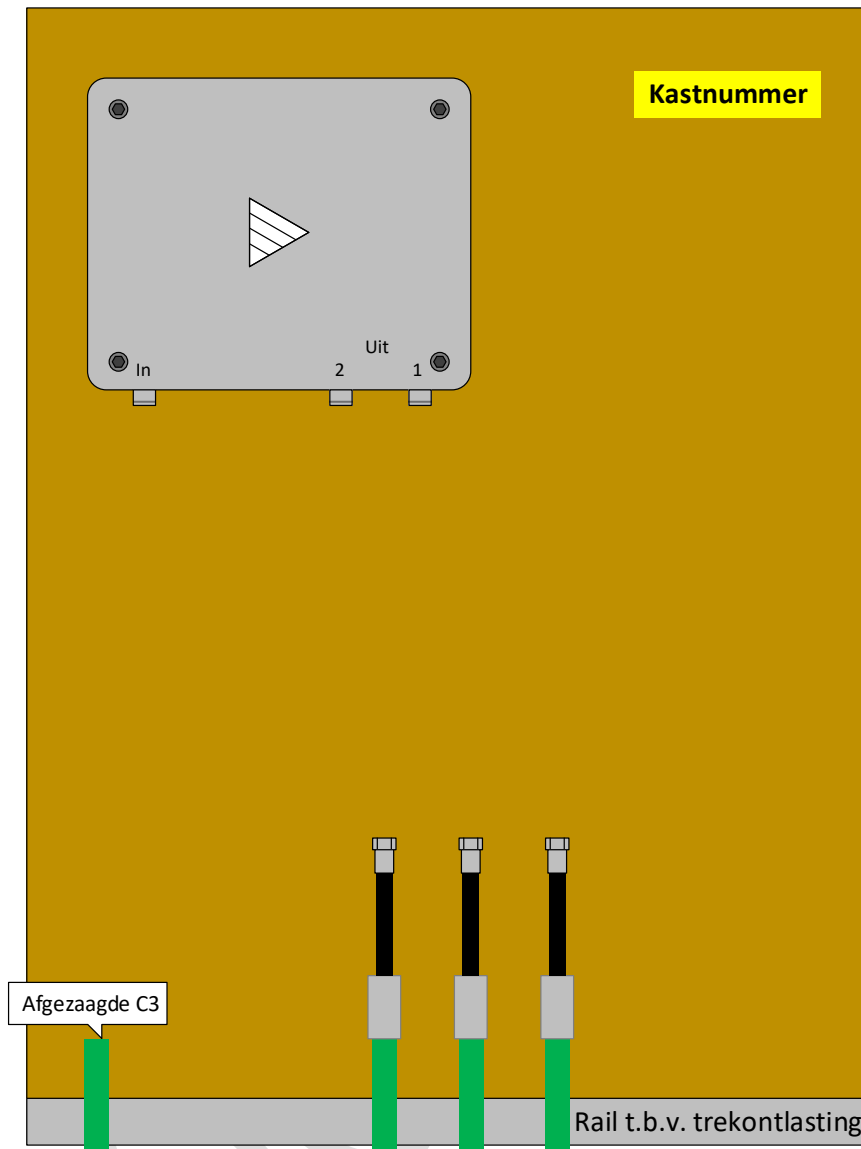

### 1.3 Eindversterker met minister

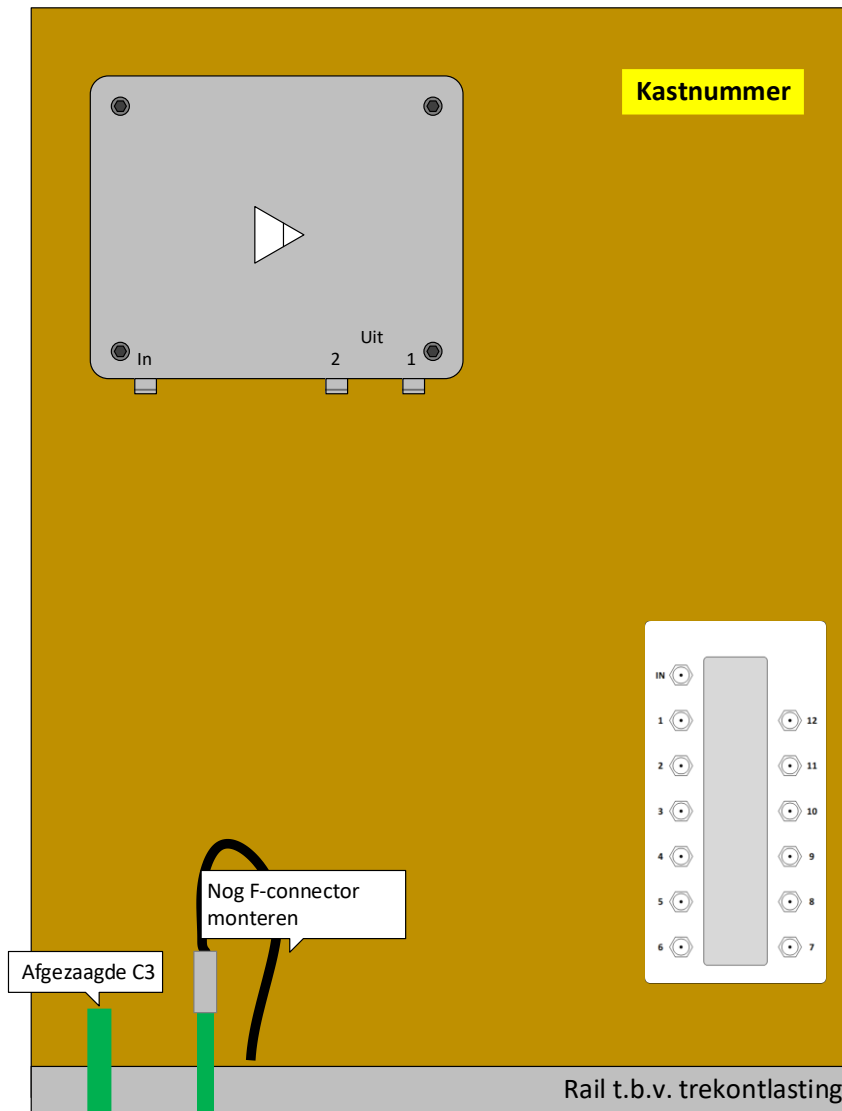

## 2 Bijlagen op locatie

### 2.1 Montagevoorschrift Wijkcentrum 1x node

Voorbeeld:

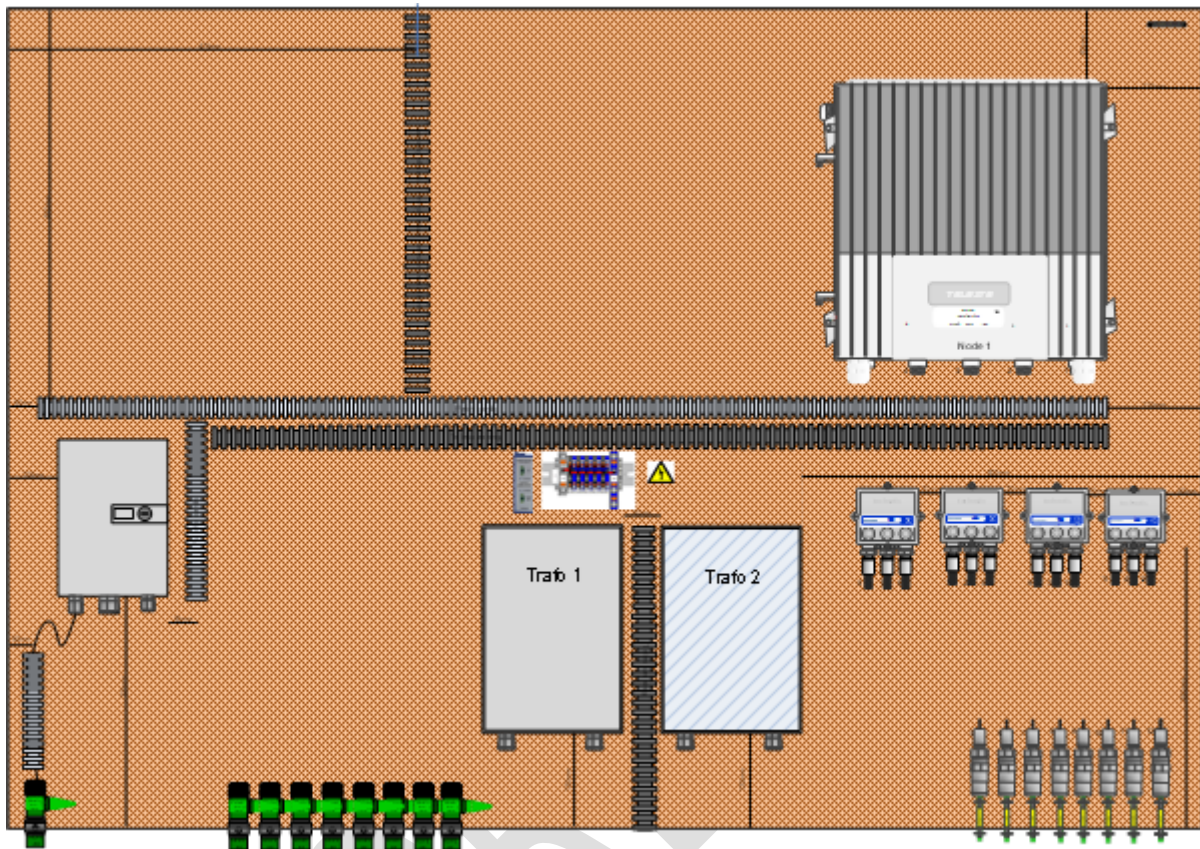

## 2.2 Montagevoorschrift groepversterker

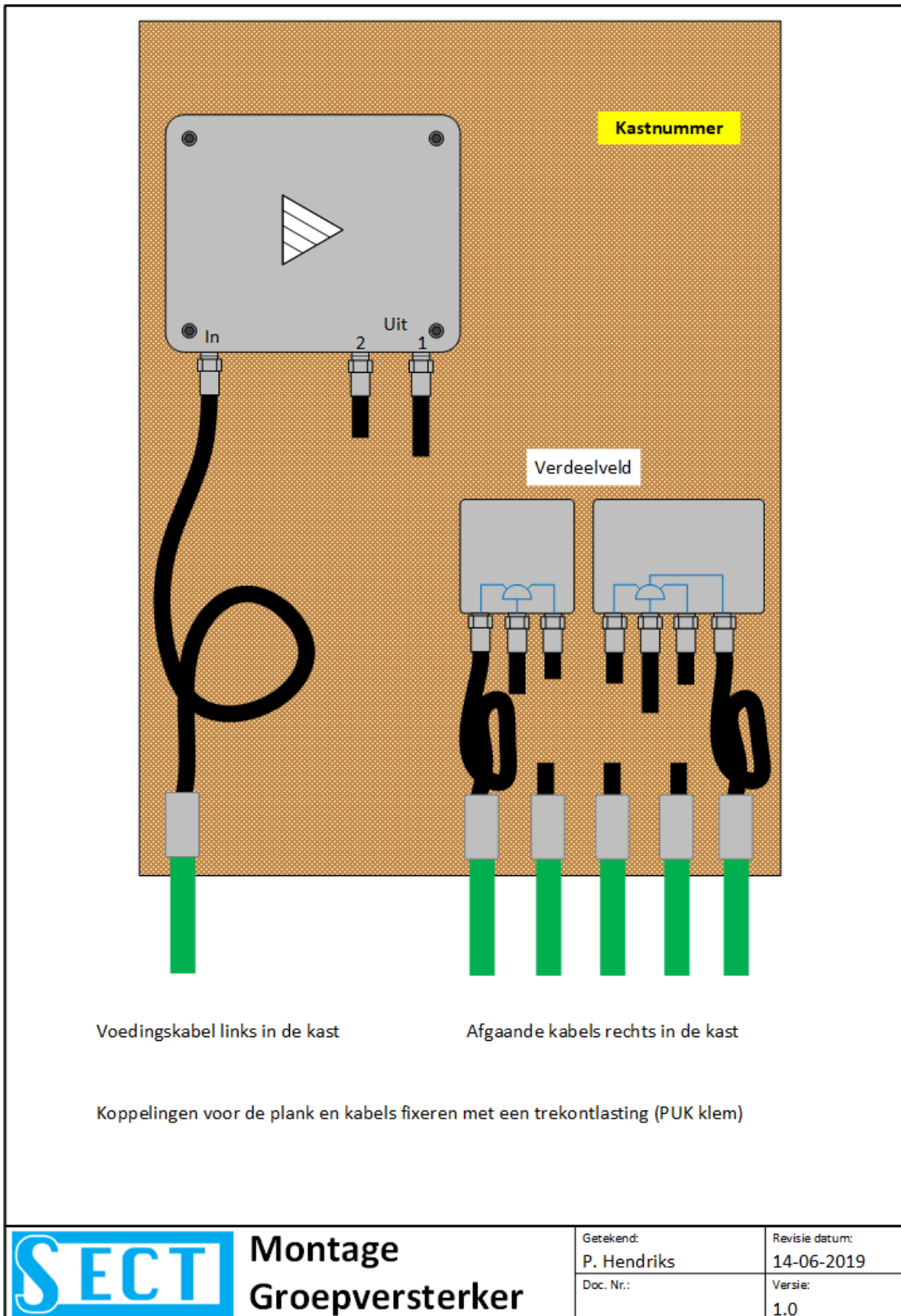

## 2.3 Montagevoorschrift eindversterker

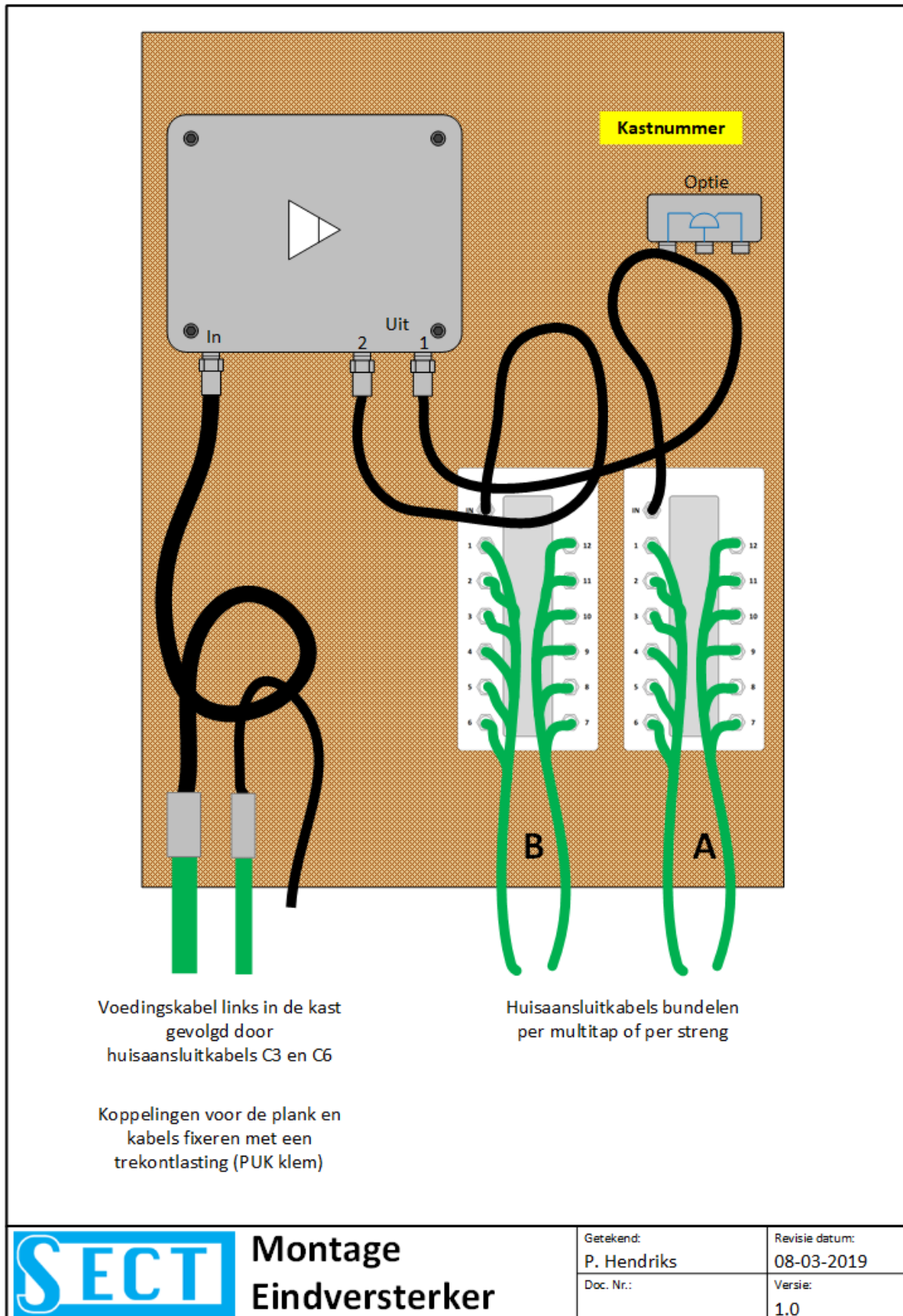

## 2.4 Ministerlijst

<b>Sterpunt-nr.:</b>	09-01-07	<b>Type:</b>	DBC1200 type 2										
<b>WC-locatie:</b>	Hoofdstraat 1	<b>Kasttype:</b>	Z480										
<b>GV-locatie:</b>	Telestestraat 2	<b>Retour:</b>	UNI EV										
<b>EV-locatie:</b>	Bremistraat 9	<b>Aantal taps:</b>	24										
<b>Opmerking:</b>	Niveaus: QAM256	<b>Woonplaats:</b>	Trailerdorp										

<b>DBC1200 type 2</b>														
Uitgang 1 : DMV12 C9														
Uitgang 2 : -----														
	<b>85</b>	<b>440</b>	<b>470</b>	<b>860</b>										
<b>In:</b>	23	20	18	15										
<b>Uit:</b>	35	35	35	35										
<b>Uit:</b>	35	35	35	35										

  

MT	Tp	Straat	Nr	Toev	R	Postcode	Kab	Len	Res	Wcd	80	232	440	536	816	Status
<b>DMV12 C9</b>																
A	1	-----					C9				153					
A	2	-----					C9				147					
A	3	-----					C9				139					
A	4	-----					C9				132					
A	5	Bremistraat	16			4061 ZZ	C6	110		85 AOP	9,5	8,8	8,9	9,1	10,1	
A	6	-----					C9				115					
A	7	-----					C9				111					
A	8	-----					C9				105					
A	9	-----					C9				99					
A	10	-----					C9				93					
A	11	-----					C9				88					
A	12	-----					C9				84					

<b>Totaal lengtes:</b>	C9	0														
	C6	110														
<b>Aantal aansluitingen:</b>	1															
<b>Generatie datum:</b>	28-7-2020															

## 2.5 Blokschema WC



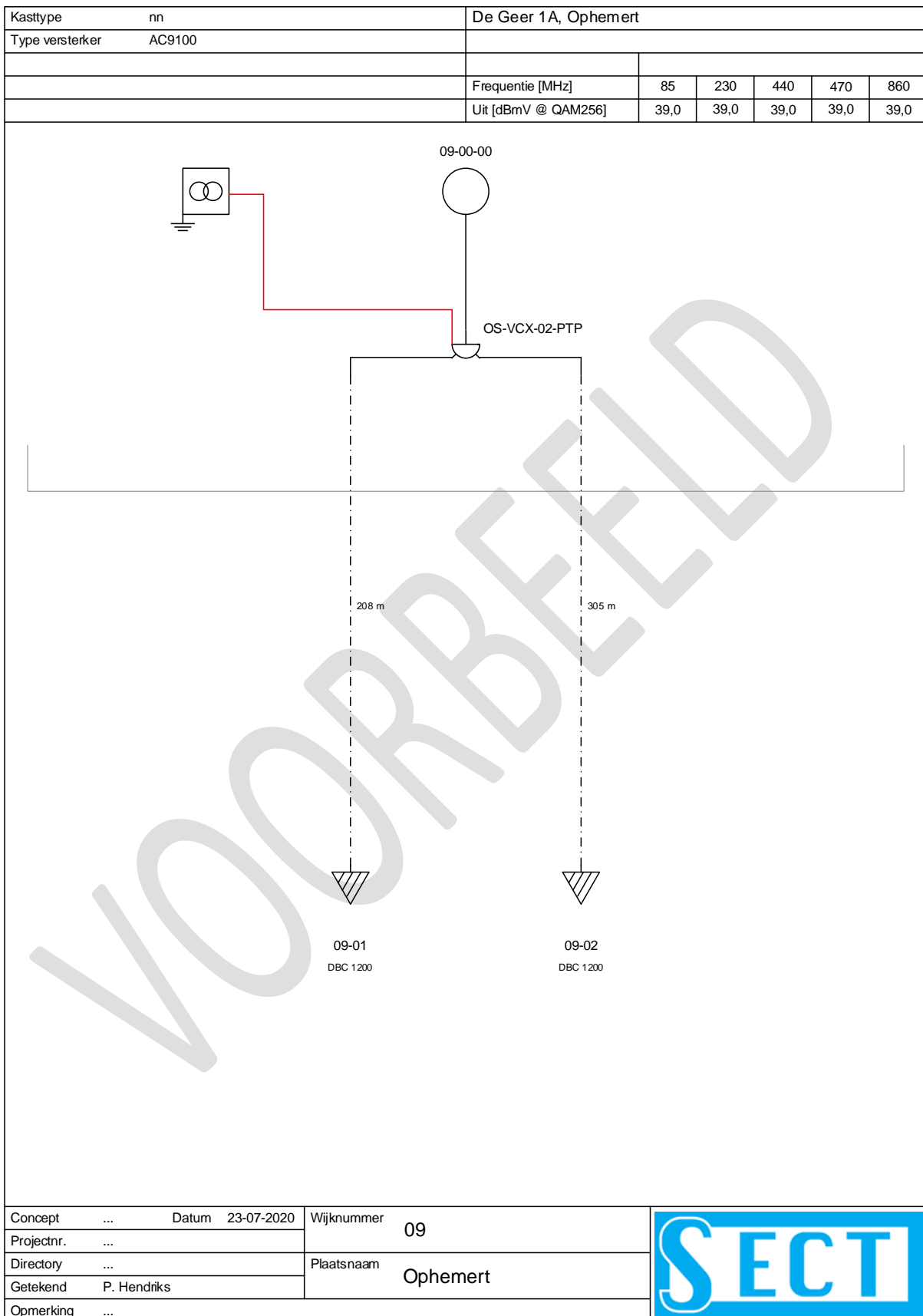

## 2.6 Blokschema GV

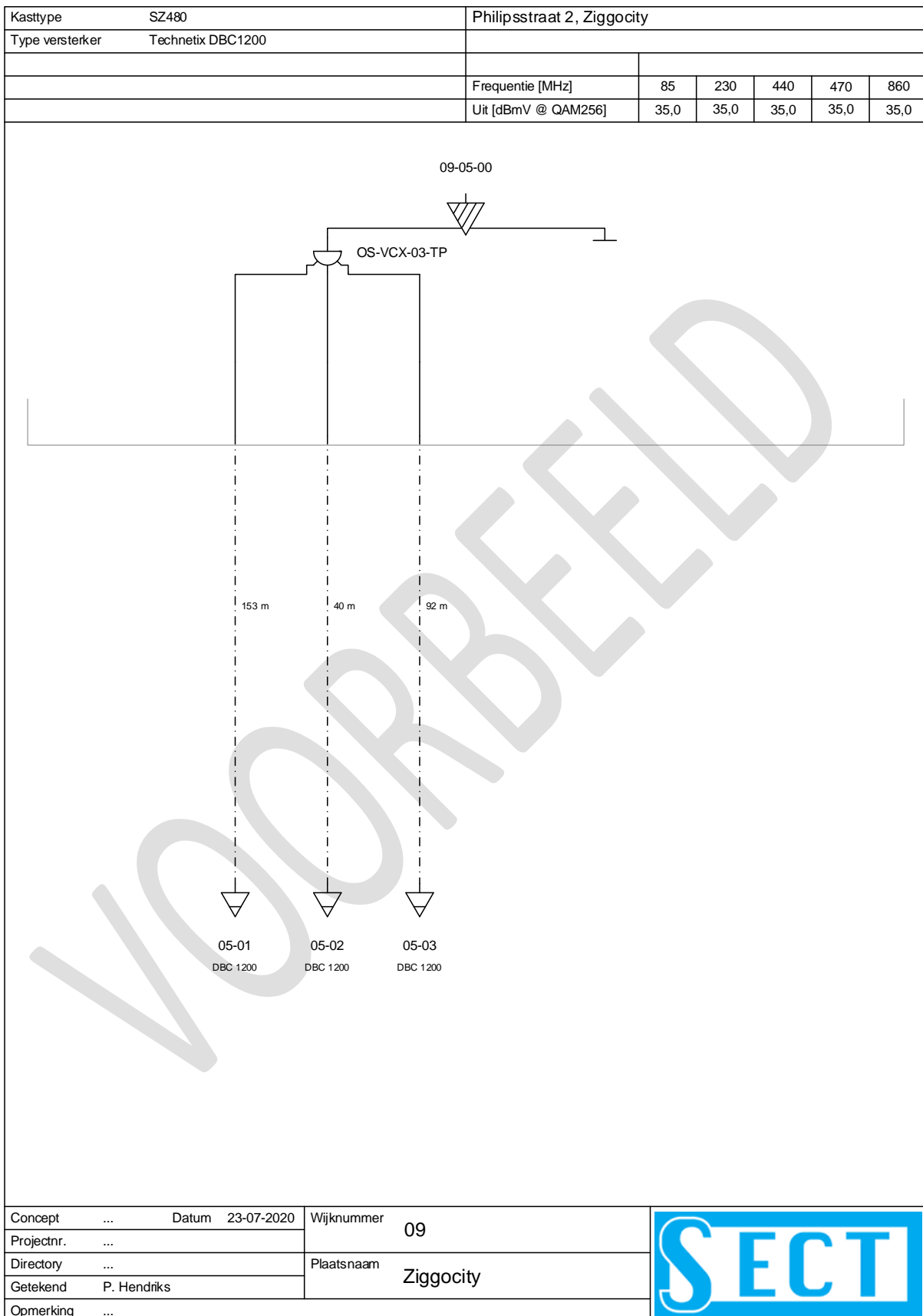

## 2.7 SECT zekeringplan

